

Extendable rotating cleaning nozzle PopUp Whirly Series 5P2/5P3



Features:

- Pressure-dependent automatically extending rotating cleaning nozzle
- Can be installed flush in the tank wall
- Suitable for cleaning pipes and applications that use foam
- Particularly suitable for applications in the pharmaceutical, chemical and food and beverage industry



**ATEX version
on request**



Series 5P2



Series 5P3

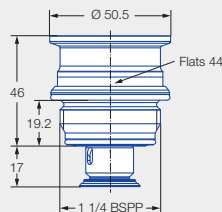

Male thread

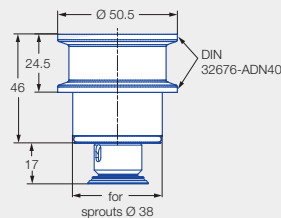

Tri-Clamp connection¹

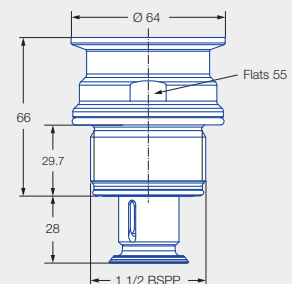
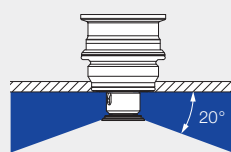

Male thread

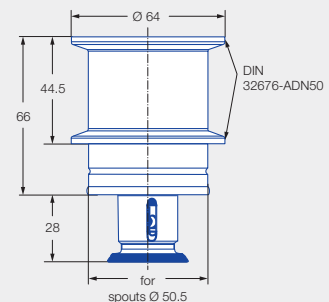

Tri-Clamp connection²

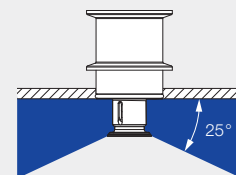

Installation situation 5P2/5P3

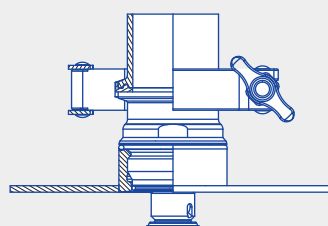

Male thread

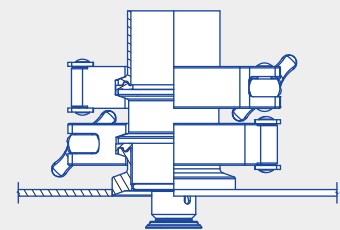

Tri-Clamp connection

¹ A clamp according to DIN 32676-A with a connection diameter of 50.5 mm is required to connect the nozzle to the weld-in flange.

² A clamp according to DIN 32676-A with a connection diameter of 64.0 mm is required to connect the nozzle to the weld-in flange.

Weld-in flange for Tri-Clamp connection

A 2 mm thick gasket must be used if the PopUp Whirly is installed with the weld-in flange.

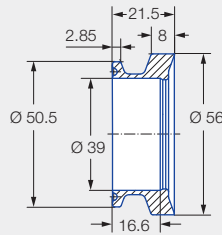

Ordering no.: 050.020.1Y.01.00
Material: Stainless steel 316L

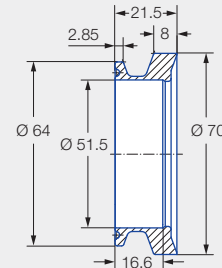

Ordering no.: 050.020.1Y.01.01
Material: Stainless steel 316L



Max. temperature
140 °C



Installation
Operation in every direction is possible



Bearing
Slide bearing



Material
Stainless steel 316L,
stainless steel 316Ti,
stainless steel 316,
FKM



Recommended operating pressure
2 bar
5P2: Opening pressure approx. 1.0 bar, closing pressure approx. 0.5 bar,
5P3: Opening pressure approx. 0.9 bar, closing pressure approx. 0.5 bar





Filtration
Line strainer with a mesh size of 0.3 mm/50 mesh

Function video

www.lechler.com/de-en/medialibrary/videos-general-industry
Or scan the QR code.



Spray angle	Ordering no.				Narrowest free cross section Ø [mm]	V̇ water [l/min]			
	Type	Code				p [bar] (p _{max} = 5 bar)			
		1 1/4 BSPP	1 1/2 BSPP	Tri-Clamp		1.0	2.0	3.0	at 40 psi [US gal/min]
20° 	5P2.873.1Y.AP	●			2.5	11	15	18	5
	5P2.873.1Y.00			●	2.5	11	15	18	5
	5P2.923.1Y.AP	●			3.5	14	20	25	6
	5P2.923.1Y.00			●	3.5	14	20	25	6
25° 	5P3.043.1Y.AR		●		3.3	28	40	49	12
	5P3.043.1Y.00			●	3.3	28	40	49	12

Detailed information can be found in our brochure "Tank and Equipment Cleaning" as well as at www.lechler.com/de-en/tankcleaningnozzles.

The maximum tank diameter applies to the recommended operating pressure and is meant as a recommendation only. The cleaning result is also affected by the type of soiling.

Information on operation

- The PopUp Whirly is not suitable for operation with compressed air or any other gas.
- Operation above the recommended operating pressure has a negative impact on the cleaning result and wear.